

**FAG****N211-E-XL-TVP2**

Cylindrical roller bearing

Schaeffler ID:
0167337890000

Cylindrical roller bearing N2..-E-TVP, with cage, single row, non-locating bearing, 0 ribs on outer ring, 2 rib on inner ring, type N2

Technical information

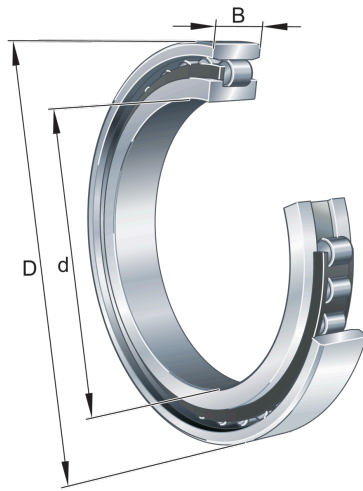
**Main Dimensions & Performance Data**

d	55 mm	Bore diameter
D	100 mm	Outside diameter
B	21 mm	Width
C_r	99,000 N	Basic dynamic load rating, radial
C_{0r}	95,000 N	Basic static load rating, radial
C_{ur}	16,400 N	Fatigue load limit, radial
$n_{G Grease}$	8,500 1/min	Limiting speed for grease lubrication
$n_{G Oil}$	10,000 1/min	Limiting speed for oil lubrication
	0.65 kg	Weight

Dimensions

$r_{1 min}$	1.1 mm	Minimum chamfer dimension
s_1	0.8 mm	Axial displacement
E	90 mm	Raceway diameter outer ring

Mounting dimensions

$d_{a min}$	62 mm	Minimum diameter shaft shoulder
$D_{a max}$	91 mm	Maximum diameter of housing shoulder
$r_{a1 max}$	1.5 mm	Maximum recess radius

Temperature range

T_{min}	-30 °C	Operating temperature min.
T_{max}	120 °C	Operating temperature max.